

Version
3.ZN70.001
3.ZN70.002

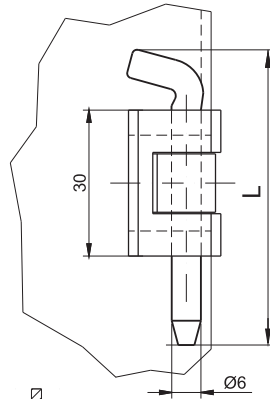

Version
3.ZN70.003

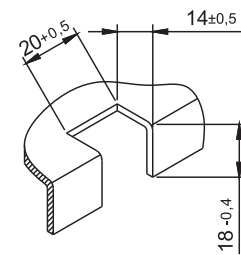
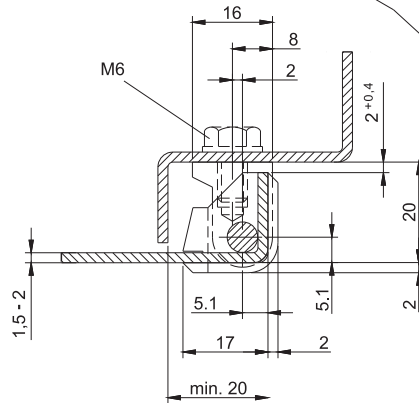
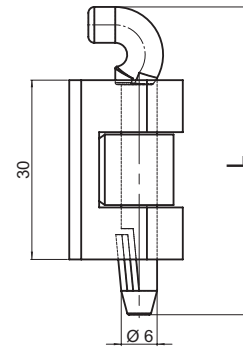

Mounting hole

CATALOGUE NO.	DIMENSION L [mm]		COMPONENTS	MATERIAL	FINISH [C]				
					Chrome	Nickel	RAL9005	RAL7035	RAL7032
3.ZN70.001	56,5	70	Holder, Base Pin	ZAMAK 5 Steel zinc plated	01	02	04	05	12
3.ZN70.003	51,5		Holder, Base Pin	ZAMAK5 POM					
3.ZN70.002SN	56,5	70	Holder, Base, Pin	Stainless steel	-				

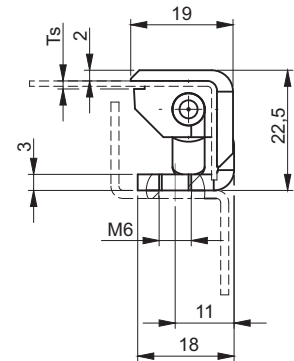
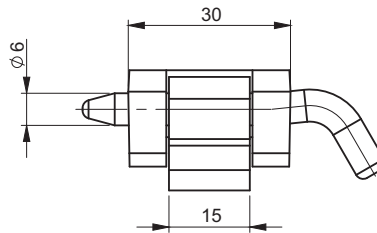
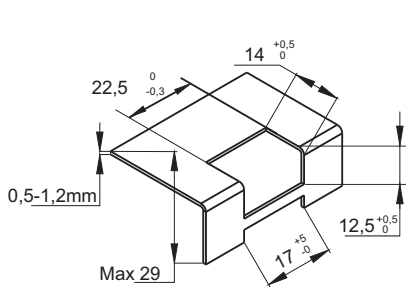

Ts - thickness of metal sheet [mm]

CATALOGUE NUMBER	Ts [mm]	COMPONENTS	MATERIAL	FINISH [C]			
				Chrome	Nickel	RAL9005	RAL7035
3.ZN75.003	0,8-1,2	Holder, Base Pin	ZAMAK 5 Steel zinc plated	01	02	04	05
3.ZN75.004	1,5-2,0	Holder, Base Pin	ZAMAK 5 Steel zinc plated				

How to order:

Catalogue number
Dimension
Finish

